

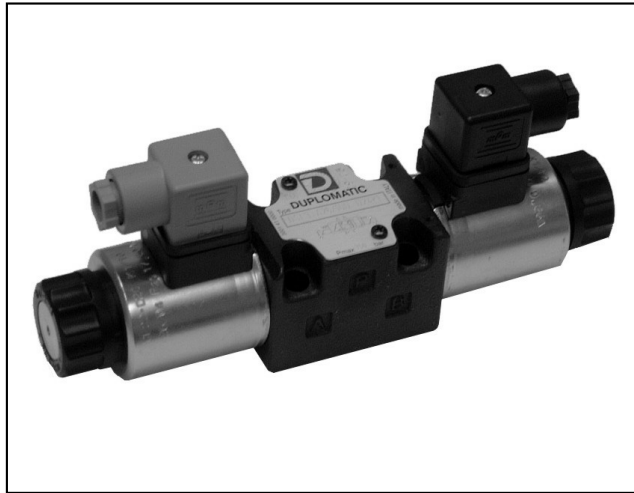

DIPLOMATIC
HYDRAULICS

83 210/105 ED



DSE3

DIRECTIONAL VALVE WITH PROPORTIONAL CONTROL SERIES 10

**SUBPLATE MOUNTING
ISO 4401-03 (CETOP 03)**

**p max 350 bar
Q max 40 l/min**

MOUNTING INTERFACE

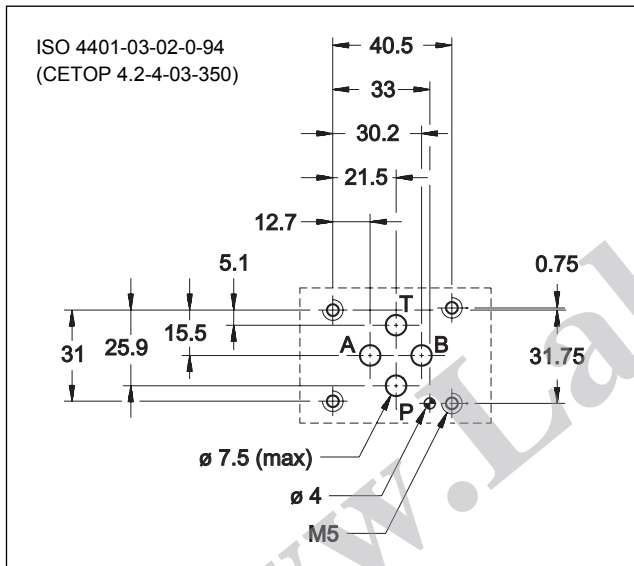

OPERATING PRINCIPLE

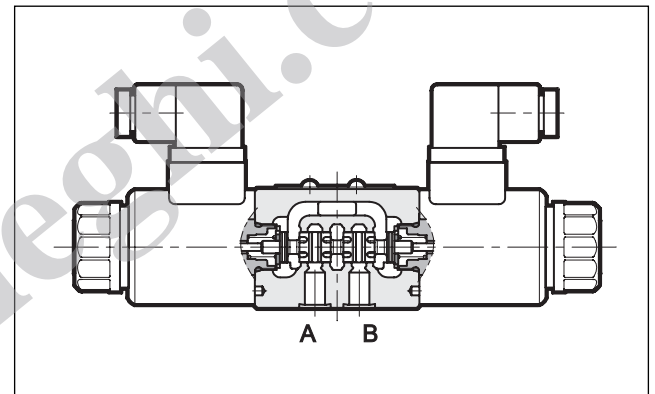

- The DSE3 valve is a directly operated directional control valve with electric proportional control and with ports in compliance with ISO 4401 standards (CETOP RP 121H).
- It is used for directional and speed control of the hydraulic actuators.
- Valve opening and hence flow rate can be modulated continuously in proportion to the current supplied to the solenoid.

SPECIFICATIONS (obtained with mineral oil with viscosity of 36 cSt at 50°C in conjunction with the relative electronic control units)			
Maximum operating pressure - P-A-B ports	bar	350	
-T port	bar	140	
Maximum flow with Δp 10 bar P-T	l/min	4 - 8 - 16 - 26	
Step response	see par. 8		
Hysteresis	% di Q max	< 6%	
Repeatability	% di Q max	< $\pm 1,5\%$	
Electrical characteristics	see par. 7		
Ambient temperature range	°C	-10 / +50	
Fluid temperature range	°C	-20 / +80	
Fluid viscosity range	cSt	10 ÷ 400	
Recommended viscosity	cSt	25	
Fluid contamination degree	According to NAS 1638 class 7 ÷ 9		
Mass	single solenoid valve	kg	1,6
	double solenoid valve		2

- The valve can be controlled directly by a current control supply unit or by means of the relative electronic control units to exploit valve performance to the full (see par. 10).

HYDRAULIC SYMBOLS (typical)

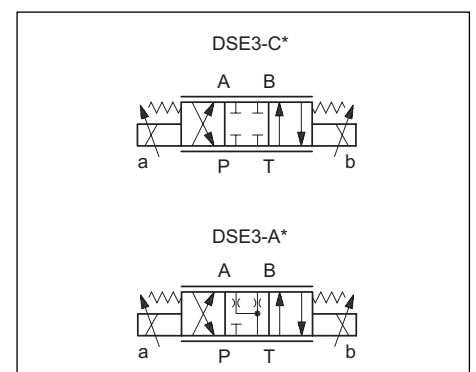



1 - IDENTIFICATION CODE

D	S	E	3	-					/ 10	-			K1	/	
----------	----------	----------	----------	----------	--	--	--	--	-------------	----------	--	--	-----------	----------	--

Directly operated directional control valve

Electric proportional control

Size ISO 4401-03 (CETOP 03)

Spool type:
C = closed centers
A = open centers

Spool nominal flow (see table 2)

Solenoid position (omit for configuration with two solenoids):
SA = 1 solenoid on side A
SB = 1 solenoid on side B

Manual override (see par. 9)

Coil electrical connection:
plug for connector type DIN 43650 (**standard**)

D12 = Nominal solenoid voltage 12 VCC
D24 = Nominal solenoid voltage 24 VCC

Seals:
N = NBR seals for mineral oil (**standard**)
V = FPM seals for special fluids

Series No. (from 10 to 19 sizes and mounting dimensions remain unchanged)

2 - CONFIGURATIONS

Valve configuration depends on the combination of the following elements:
number of proportional solenoids, spool type, nominal flow rate.

2 solenoids configuration:
3 positions with spring centering

"SA" configuration: 1 solenoid on side A.
2 positions (central + external) with spring centering

"SB" configuration: 1 solenoid on side B.
2 positions (central + external) with spring centering

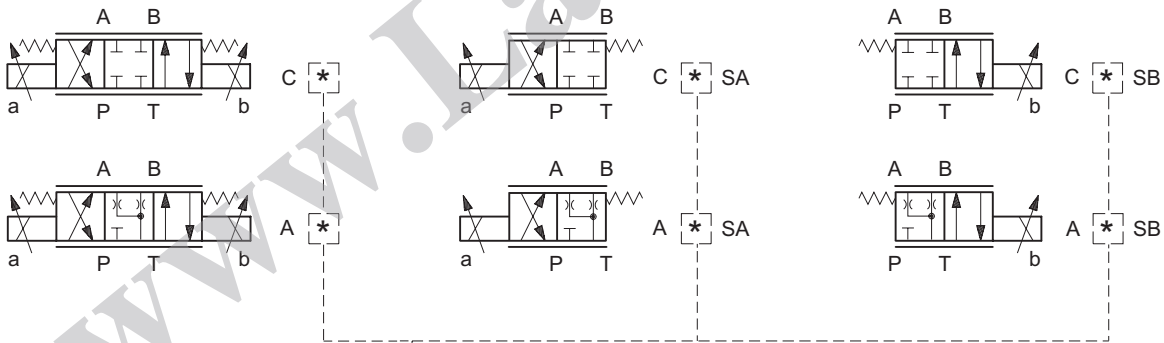

*	Controlled flow with Δp 10 bar P-T
04	4 l/min
08	8 l/min
16	16 l/min
26	26 l/min



3 - CHARACTERISTIC CURVES (values measured with viscosity of 36 cSt at 50°C with valves connected to the relative electronic control units)

Typical constant flow rate control curves at Δp according to current supply to solenoid (D24 version, maximum current 860 mA), measured for the various spool types available.

The reference Δp values are measured between ports P and T on the valve.

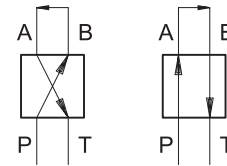

SPOOL TYPE C04

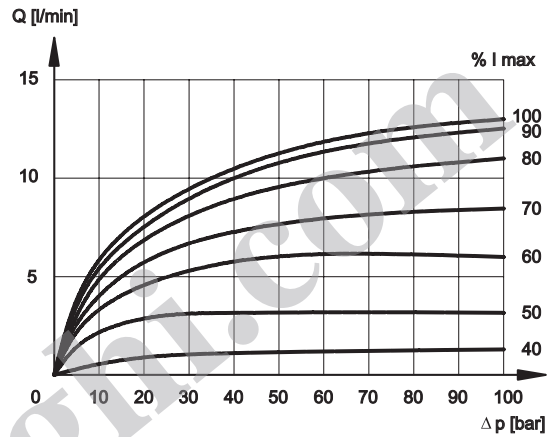
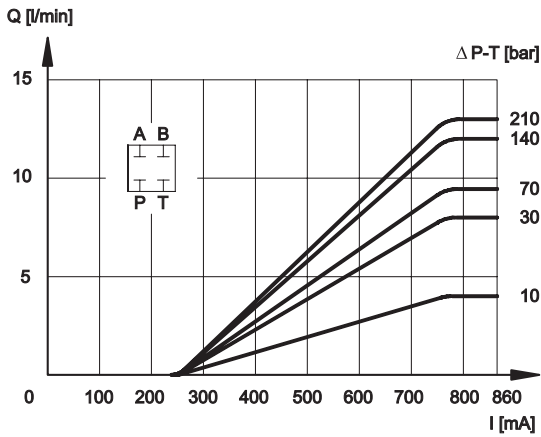

SPOOL TYPE C08

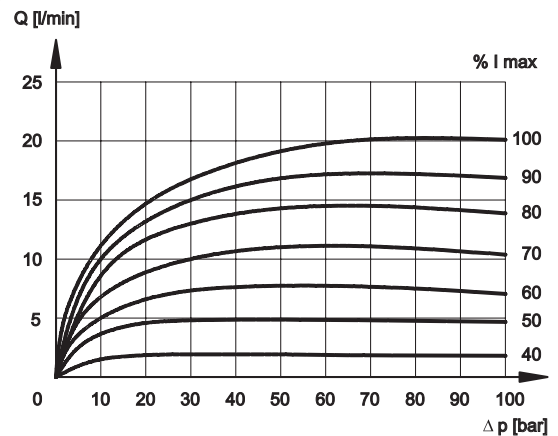
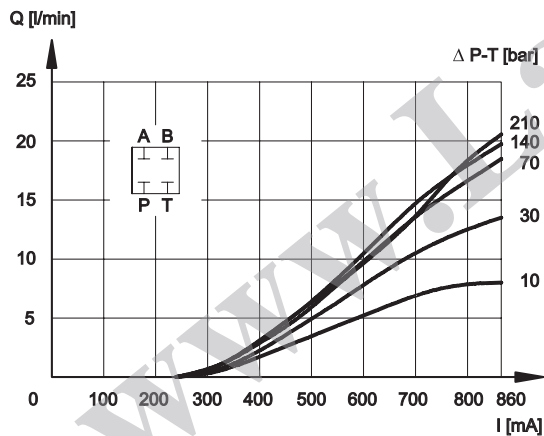

SPOOL TYPE C16

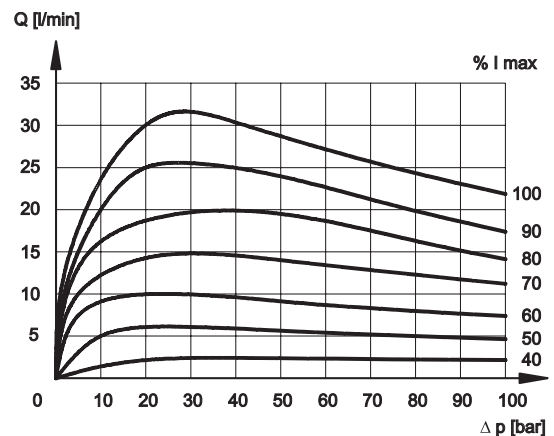
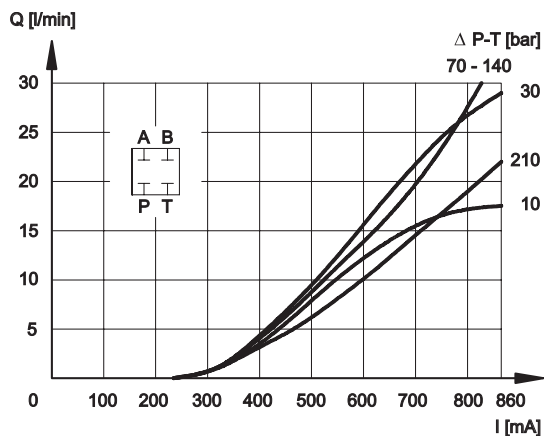



SPOOL TYPE C26

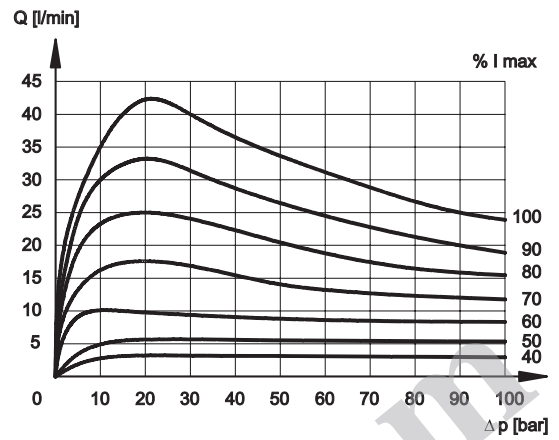
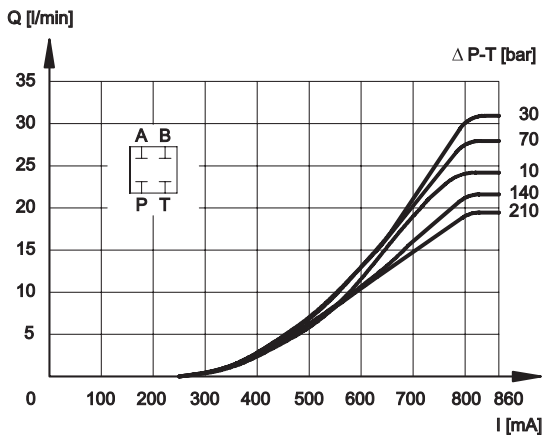

SPOOL TYPE A04

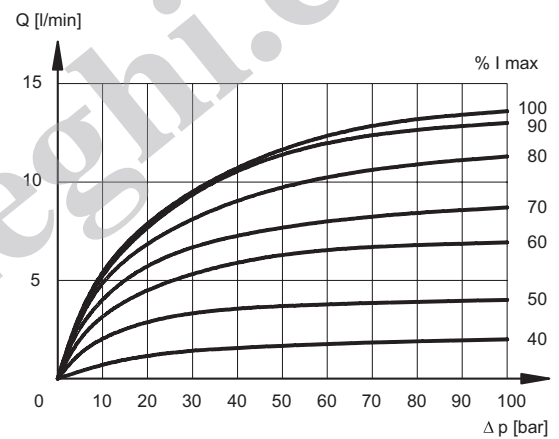
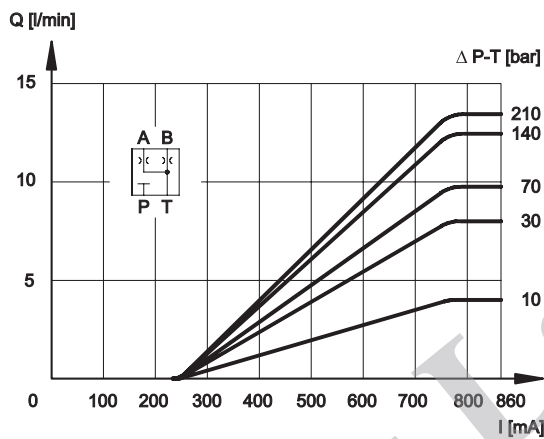

SPOOL TYPE A08

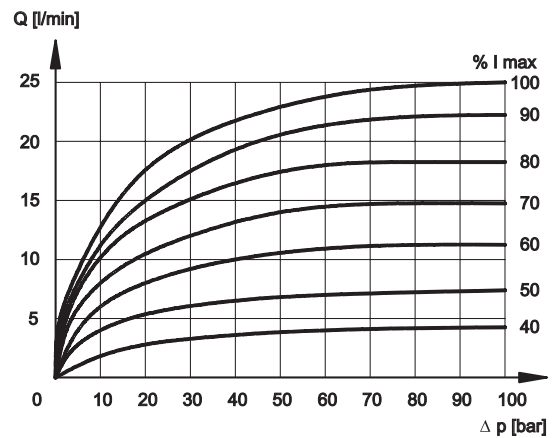
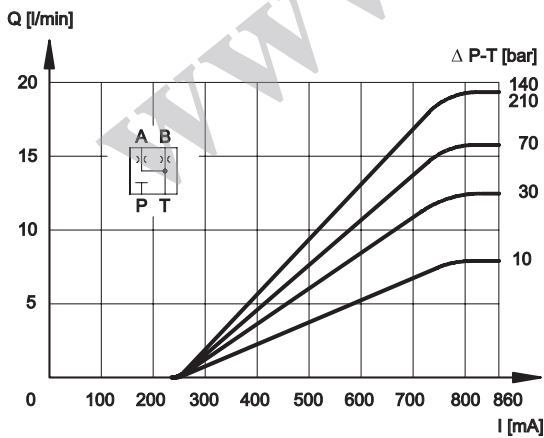



SPOOLTYPE A16

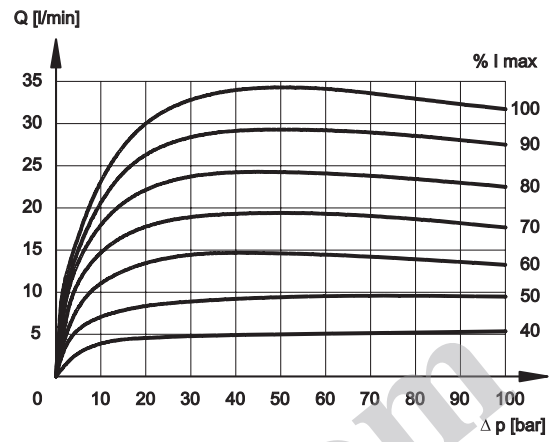
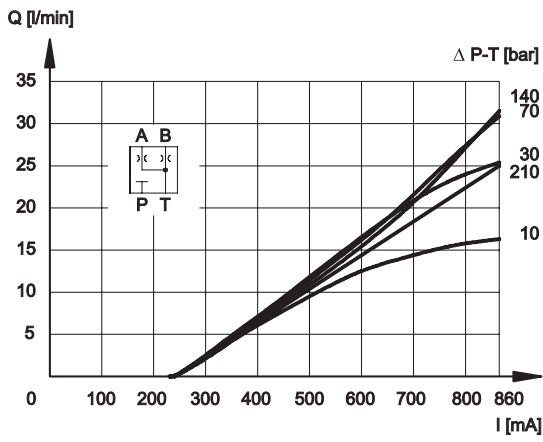

SPOOL TYPE A26

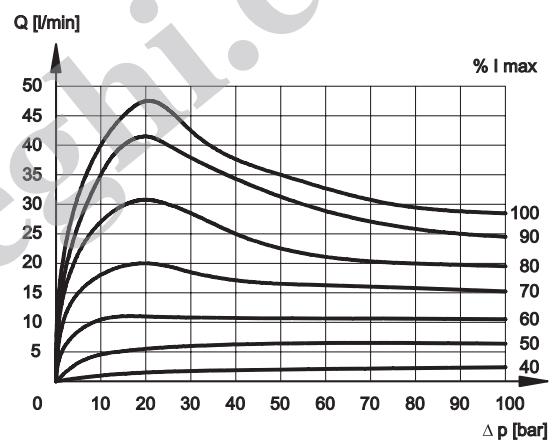
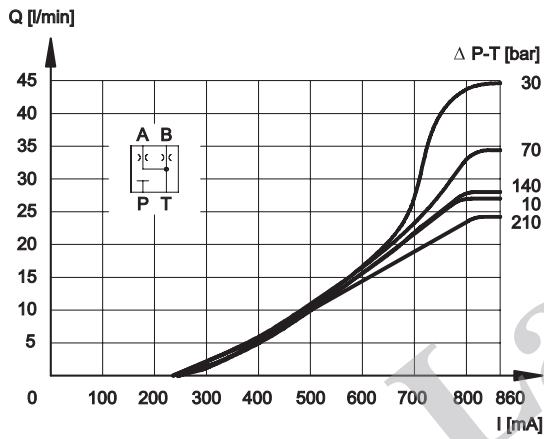



4 - HYDRAULIC FLUIDS

Use mineral oil-based hydraulic fluids HH, HL or HM type, according to ISO 6743-4.

For fluids HFDR (phosphate esters) use FPM seals (code V).

For use with other types of fluids such as HFA, HFB, HFC please consult our technical department.

Operation with fluid temperature exceeding 70°C causes premature deterioration of the quality of the fluid and seals.

The physical and chemical properties of the fluid must be maintained.

5 - ELECTRICAL CHARACTERISTICS

Proportional solenoid

The proportional solenoid comprises two parts: tube and coil.

The tube, screwed to the valve body, contains the armature which is designed to maintain friction to a minimum thereby reducing hysteresis.

The coil is mounted on the tube secured by means of a lock nut. It can be rotated through 360° depending on installation clearances.

NOMINAL VOLTAGE	VCC	12	24
COIL OPERATING VOLTAGE	VCC	9	20
RESISTANCE (at 20°C)	Ω	3,66	17,6
MAXIMUM CURRENT	A	1,88	0,86
DUTY CYCLE	100%		
ELECTROMAGNETIC COMPATIBILITY (EMC) - EMISSIONS EN 50081-1 - IMMUNITY EN 50082-2	in compliance with 89/336 CEE		
PROTECTION TO ATMOSPHERIC AGENTS (according to IEC 144 standards)	IP 65		

6 - STEP RESPONSE (measured with mineral oil with viscosity of 36 cSt at 50°C in conjunction with the relative electronic control units)

Step response is the time taken for the valve to reach 90% of the set pressure value following a step change of reference signal.

The table shows typical response times tested with spool type C16 and $\Delta p=30$ bar P-T.

REFERENCE SIGNAL STEP	0→100%	100%→0
Step response [ms]		
DSE3-A*	50	40
DSE3-C*		

7 - INSTALLATION

DSE3 valves can be installed in any position without impairing correct operation.

Ensure that there is no air in the hydraulic circuit.

Valves are fixed by means of screws or tie rods on a flat surface with planarity and roughness equal to or better than those indicated in the relative symbols. If minimum values are not observed fluid can easily leak between the valve and support surface.

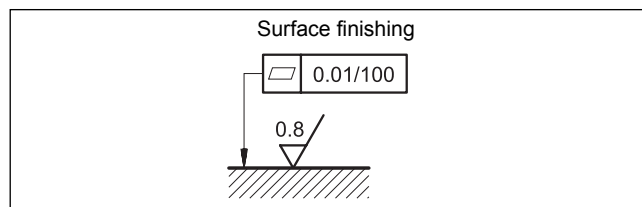



8 - OVERALL AND MOUNTING DIMENSIONS

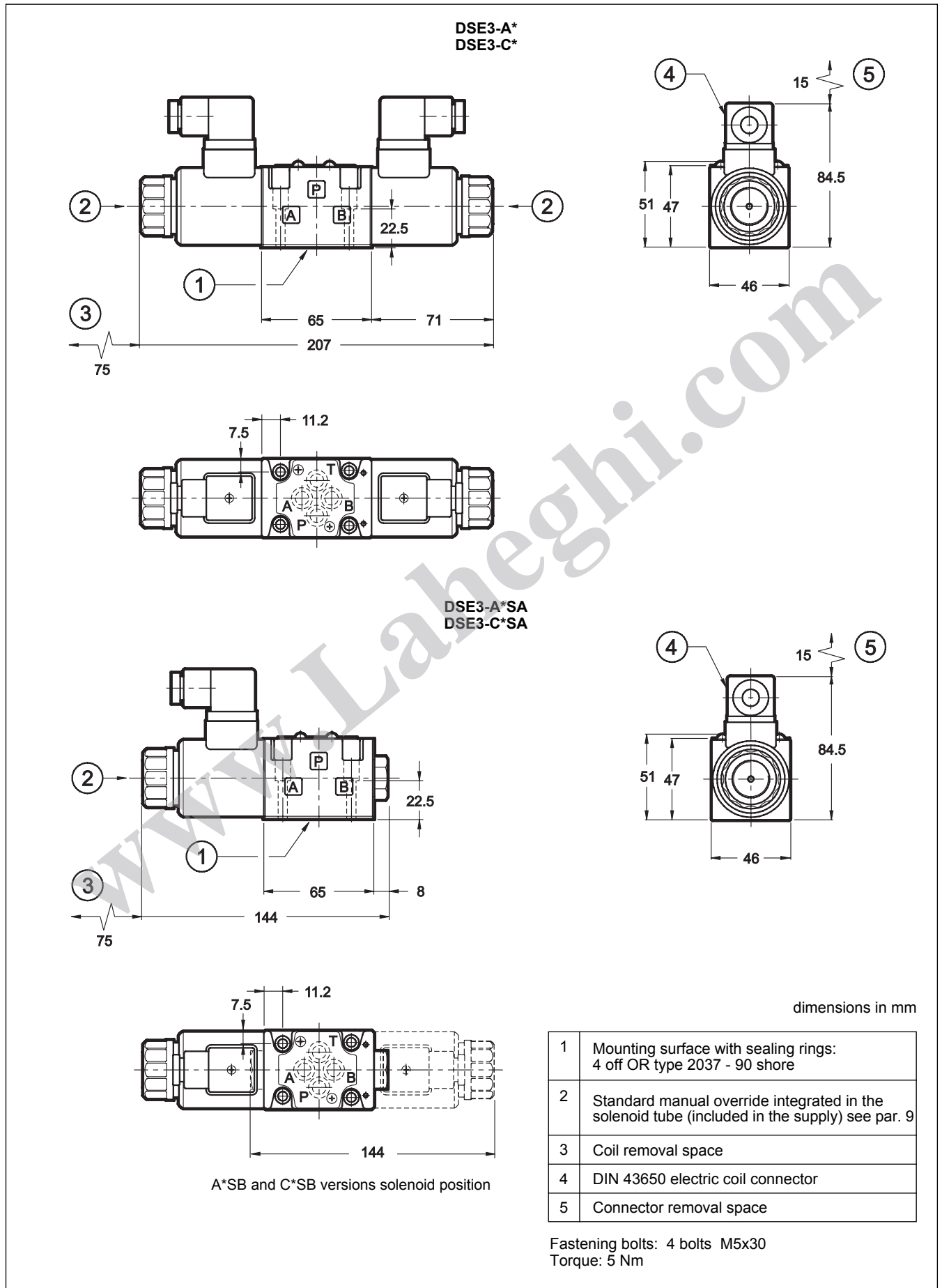



9 - MANUAL OVERRIDE

The standard valve has solenoids whose pin for the manual operation is integrated in the tube. The operation of this control must be executed with a suitable tool, minding not to damage the sliding surface.

Upon request, the CS version is available, with metal locking nut provided with a M3 x 0,75 screw and a blocking jamnut to allow the continuous and adjustable mechanical operations.

This version is sometimes used to allow the system operation even in case of damage to the electronic unit.

Another possible function of this control is the mechanical limiting of the spool outlet and consequently of the flow rate. In this case the manual override can only be used for double solenoid valves, having care of limiting the spool stroke by means of the screw which is placed opposite to the energised solenoid.

10 - ELECTRONIC CONTROL UNITS

DSE3 - ** SA (SB)

EPC-110 (for solenoids 24 Vcc)	plug version	(see cat. 89 110)
EPA-M110 (for solenoids 24 Vcc) EPA-M140 (for solenoids 12 Vcc)	rail mounting DIN EN 50022	(see cat. 89 220)
UEIK-11 (for solenoids 24 Vcc)	Eurocard type	(see cat. 89 300)

DSE3 - A* DSE3 - C*

EPA-M210 (for solenoids 24 Vcc) EPA-M240 (for solenoids 12 Vcc)	rail mounting DIN EN 50022	(see cat. 89 220)
UEIK-21 (for solenoids 24 Vcc)	Eurocard type	(see cat. 89 320)

11 - SUBPLATES (see cat. 51 000)

Type PMMD-AI3G ports on rear
Type PMMD-AL3G side ports
Port dimensions: P, T, A, B: 3/8" BSP

 DIPLOMATIC HYDRAULICS	DIPLOMATIC OLEODINAMICA SpA 20025 LEGNANO (MI) - P.le Bozzi, 1 / Via Edison Tel. 0331/472111 - Fax 0331/548328	
---	---	--